

NOTE: FOR MORE DETAILS SEE YOUR V.P.CUSTOMER SERVICE REP.

REVISIONS			
REV.	DESCRIPTION	DATE	APPROVED
A	INITIAL RELEASE	09-11-97	
B	CO 046 Drafting Update		

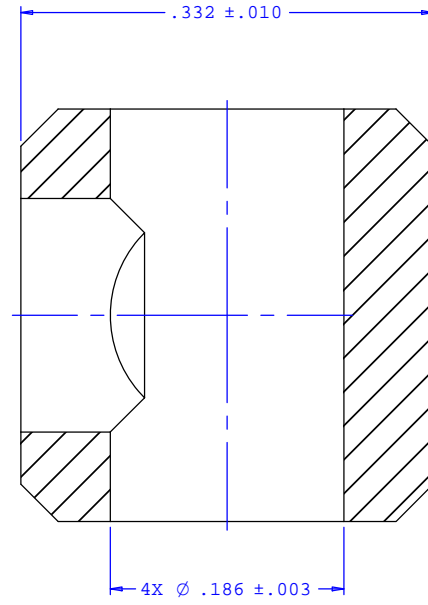

SECTION A-A

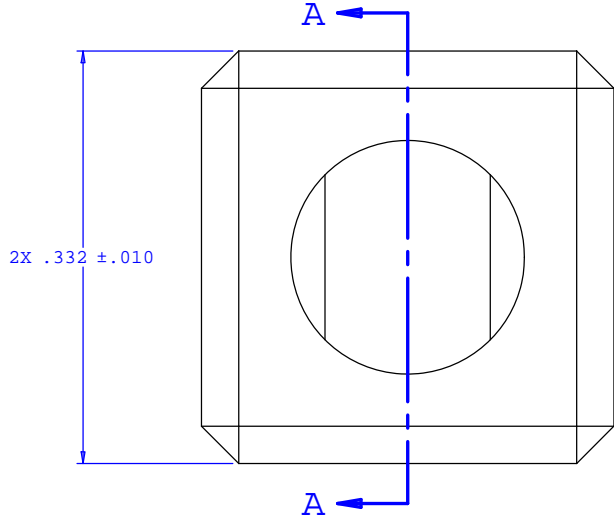
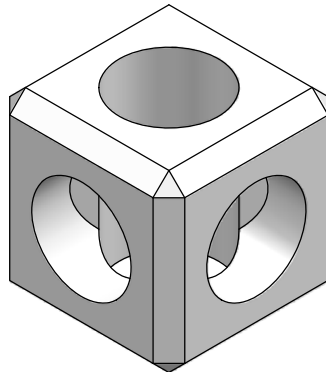

UNLESS OTHERWISE SPECIFIED DIMENSIONS ARE IN INCHES TOLERANCES ARE:		VALUE PLASTICS, INC.	
FRACTIONS ±	DECIMALS .XX ±.01 .XXX ±.005 .XXXX ±.001	ANGULAR ±1°	PART NUMBER: BDJ06
DO NOT SCALE DRAWING		DESCRIPTION: Bondable Junction Block	
DRAWN BY: Frank Lombardi	DATE: 05-02-06	SIZE: B	SCALE: NTS
Engineer/Manager: Rick Cairns		DRAWING NUMBER: 1008728	REV. B
		© 2006 VALUE PLASTICS, INC.	SHEET: 1 OF 1

FOR REFERENCE ONLY